

SENA



SR

**MOTORCYCLE BLUETOOTH®
COMMUNICATION SYSTEM**

HD SPEAKERS

USER'S GUIDE

TABLE OF CONTENTS

1.	ABOUT THE 5R	5
1.1	Product Features	5
1.2	Product Details	6
1.3	Package Contents	7
2.	INSTALLING THE HEADSET ON YOUR HELMET	8
2.1	Preparing the Helmet for Installation	8
2.2	Using the Clamp for Headset Main Unit	8
2.3	Using the Glued Surface Mounting Adapter for Headset Main Unit	9
2.4	Installing the Speakers	10
2.5	Installing the Microphone	11
2.5.1	Installing the Wired Boom Microphone	11
2.5.2	Installing the Wired Microphone	13
2.6	Cables Organization	14
2.7	Adjusting the Wired Boom Microphone Position	14
3.	GETTING STARTED	15
3.1	Downloadable Sena Software	15
3.1.1	Sena Motorcycles App	15
3.1.2	Sena Device Manager	15
3.2	Charging	15
3.3	Legend	16
3.4	Powering On and Off	16
3.5	Checking the Battery Level	17
3.6	Volume Adjustment	17

4.	PAIRING THE HEADSET WITH OTHER BLUETOOTH DEVICES	18
4.1	Phone Pairing	18
4.1.1	Initially Pairing the 5R	18
4.1.2	Pairing When the 5R is Turned Off	19
4.1.3	Pairing When the 5R is Turned On	19
4.2	Second Mobile Phone Pairing - Second Mobile Phone, GPS, and SR10	20
4.3	GPS Pairing	21
4.4	Advanced Selective Pairing: Hands-Free or A2DP Stereo	22
4.4.1	Phone Selective Pairing - Hands-Free Profile	22
4.4.2	Media Selective Pairing - A2DP Profile	23
5.	MOBILE PHONE USAGE	24
5.1	Making and Answering Calls	24
5.2	Speed Dialing	25
5.2.1	Assigning Speed Dial Presets	25
5.2.2	Using Speed Dial Presets	25
6.	STEREO MUSIC	27
6.1	Bluetooth Stereo Music	27
6.2	Music Sharing	28
7.	BLUETOOTH INTERCOM	29
7.1	Intercom Pairing	29
7.1.1	Using the Smart Intercom Pairing (SIP)	29
7.1.2	Using the Button	30
7.2	Last-Come, First-Served	31
7.3	Two-Way Intercom	32

8. UNIVERSAL INTERCOM	33
8.1 Universal Intercom Pairing	33
8.2 Two-Way Universal Intercom	34
9. FUNCTION PRIORITY AND FIRMWARE UPGRADES	35
9.1 Function Priority	35
9.2 Firmware Upgrades	35
10. CONFIGURATION SETTING	36
10.1 Headset Configuration Menu	36
10.1.1 Delete All Pairings	37
10.1.2 Remote Control Pairing	37
10.2 Software Configuration Setting	37
10.2.1 Headset Language	38
10.2.2 Audio Source Priority (Default: Intercom)	38
10.2.3 VOX Phone (Default: Enable)	38
10.2.4 VOX Intercom (Default: Disable)	38
10.2.5 Audio Multitasking™ (Default: Disable)	39
10.2.6 Background Volume (Default: Level 5)	40
10.2.7 HD Intercom (Default: Enable)	40
10.2.8 HD Voice (Default: Enable)	40
10.2.9 Voice Prompt (Default: Enable)	40
10.2.10 Advanced Noise Control™ (Always On)	40
11. TROUBLESHOOTING	41
11.1 Fault Reset	41
11.2 Factory Reset	42

1. ABOUT THE 5R

1.1 Product Features



Bluetooth® 5.1



Intercom up to 700 m (0.4 mi)*



Two-way Intercom



Audio Multitasking™



LCD Display



Firmware Upgradeable

* in open terrain

1.2 Product Details

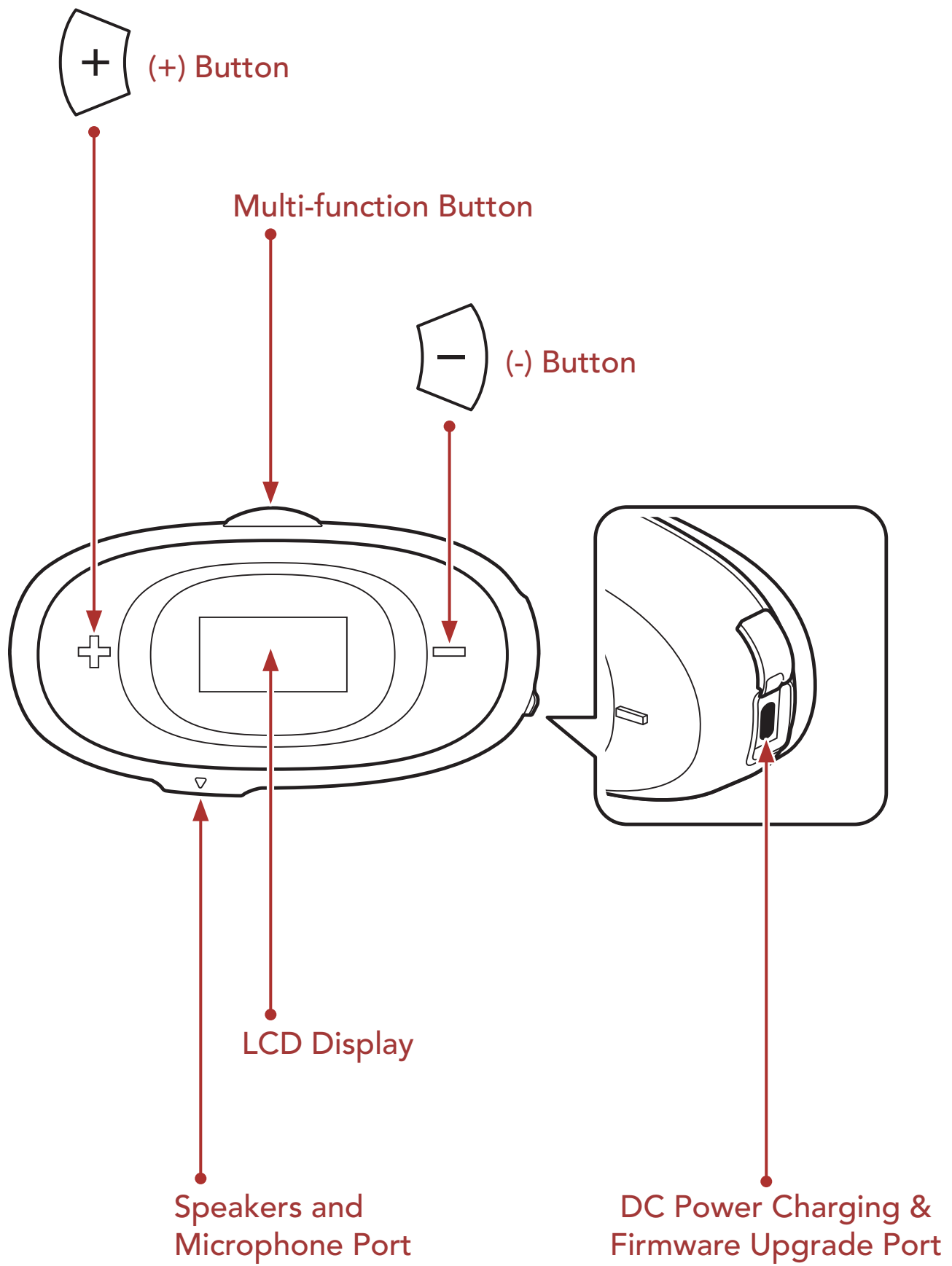

1.3 Package Contents



5R

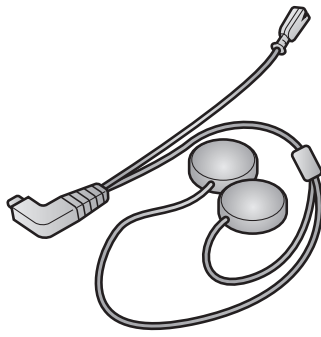

Speakers and
Microphone cable

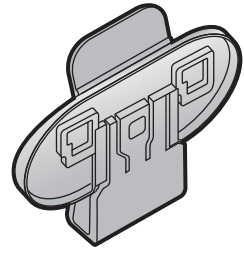

Clamp

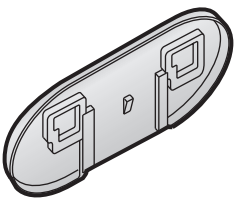

Glued Surface
Mounting Adapter

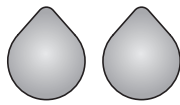

Hook and Loop
Fasteners for Speakers

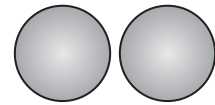

Speaker Pads

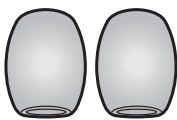

Microphone Sponges

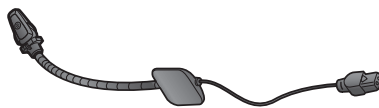

Wired Boom Microphone



Hook and Loop Fastener
for Wired Boom
Microphone

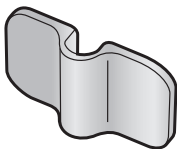

Wired Boom
Microphone Holder



Hook and Loop Fastener
for Wired Microphone
Holder



Wired Microphone
Holder

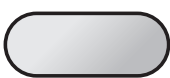

Hook and Loop Fastener
for Wired Microphone

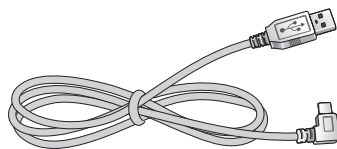

USB Power & Data Cable
(USB-C)

2. INSTALLING THE HEADSET ON YOUR HELMET

To install the headset to the helmet, follow the steps below:

2.1 Preparing the Helmet for Installation

Detach the snap fasteners located on the internal paddings. Then, remove the pads from the helmet.

2.2 Using the Clamp for Headset Main Unit

1. Insert the headset main unit into the clamp using the two connecting slots on the back.

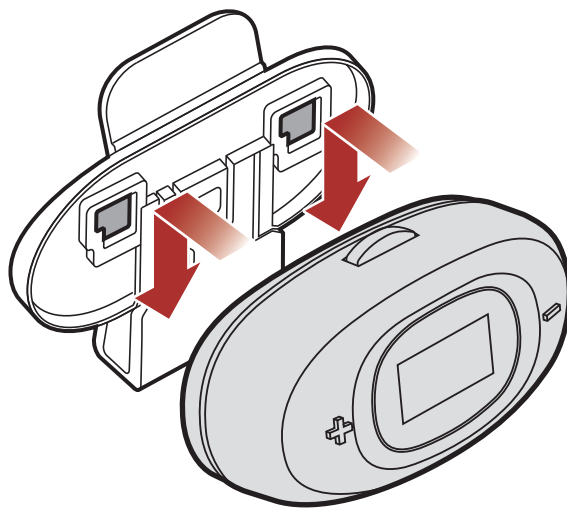

2. Insert the back plate of the clamp unit between the internal padding and external shell of the left side of the helmet.

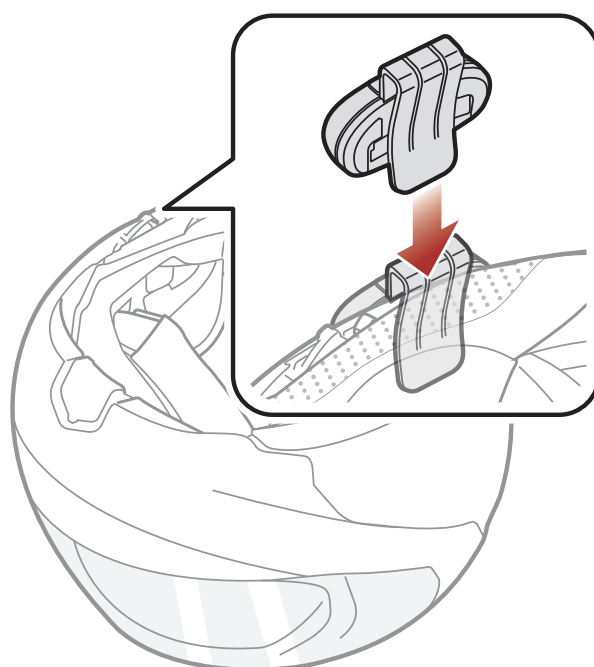

3. Align the arrows on the headset **main unit's port** with the speakers and microphone cable, and insert the speakers and microphone cable into the headset **main unit's port**.

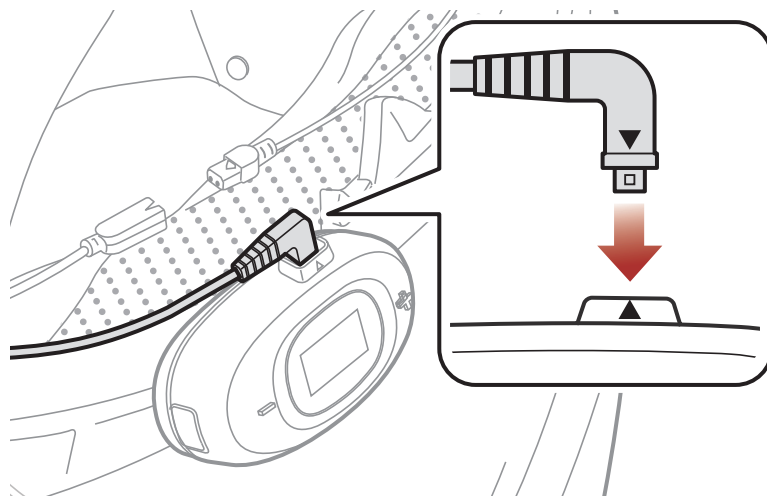

2.3 Using the Glued Surface Mounting Adapter for Headset Main Unit

1. Insert the headset main unit into the glued surface mounting adapter using the two connecting slots on the back.

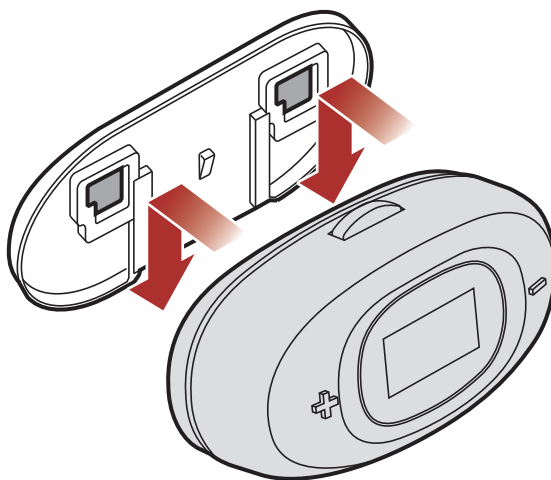

2. Clean the area on the left side of the helmet where you will attach the glued surface mounting adapter with a moistened towel and dry thoroughly.
3. Peel off the cover of adhesive tape of the glued surface mounting adapter and attach it to the left side of your helmet.

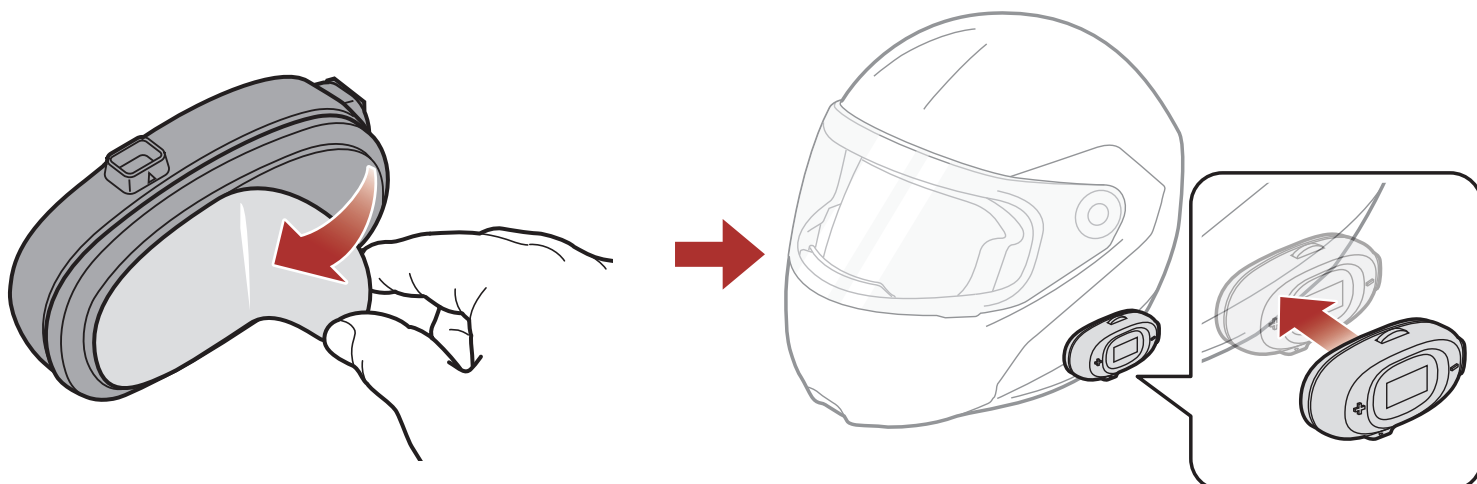

Note: Make sure that the glued surface mounting plate sticks on the helmet firmly. Maximum adhesion occurs after 24 hours.

4. Align the arrows on the headset **main unit's port** with the speakers and microphone cable, and insert the speakers and microphone cable into the headset **main unit's port**.

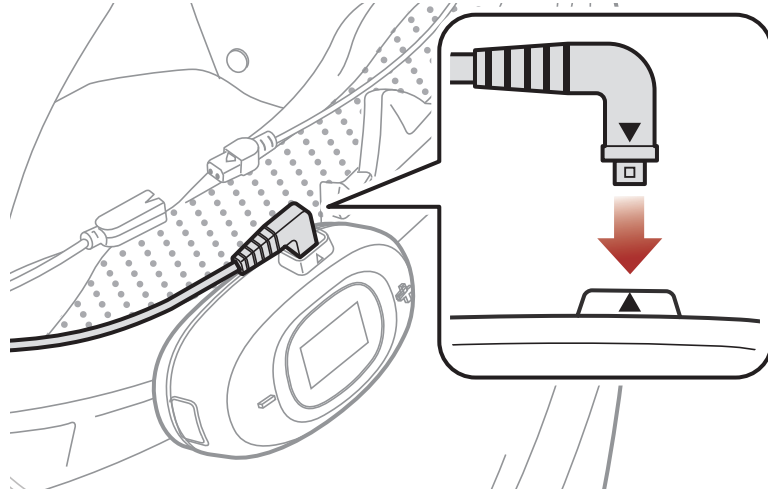

2.4 Installing the Speakers

1. Peel off the cover of adhesive tape of the hook and loop fasteners for speakers. Then, attach the hook and loop fasteners for speakers to the ear pockets inside the helmet.

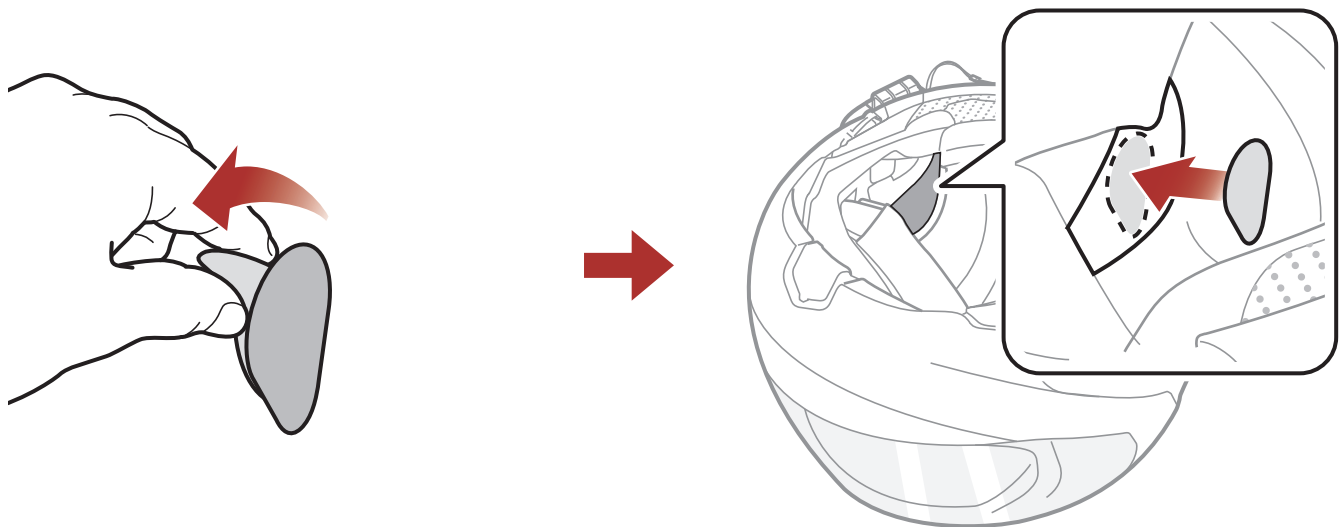

2. Attach the speakers to the hook and loop fasteners for speakers inside the helmet.

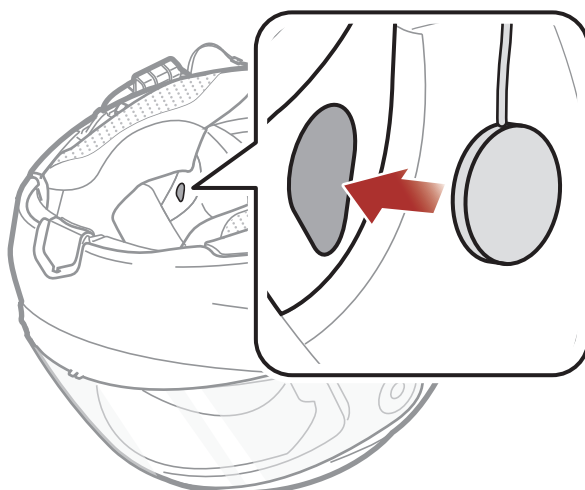

3. Repeat the process on the other side.

Note: If the helmet has deep ear pockets, you can use the speaker pads to bring the speakers closer to your ears.

2.5 Installing the Microphone

2.5.1 Installing the Wired Boom Microphone

1. Peel off the cover of the hook and loop fastener for wired boom microphone to expose the adhesive tape. Then, attach the hook and loop fastener on the inside surface of the left external shell.

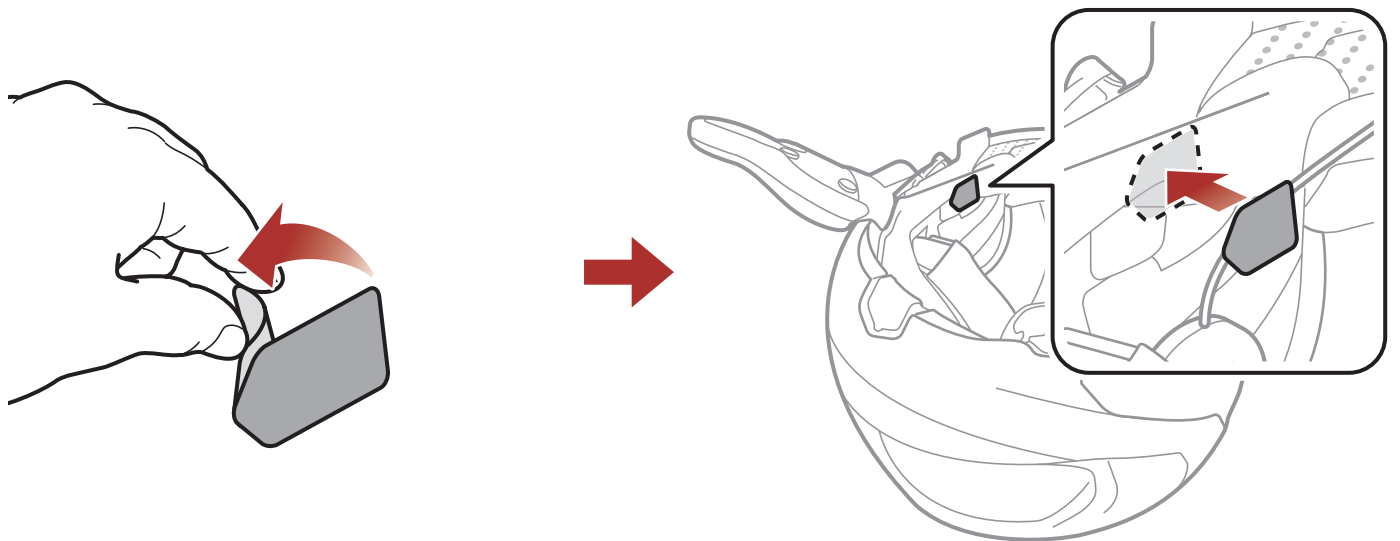

2. Attach the wired boom microphone's mounting plate to the hook and loop fastener.

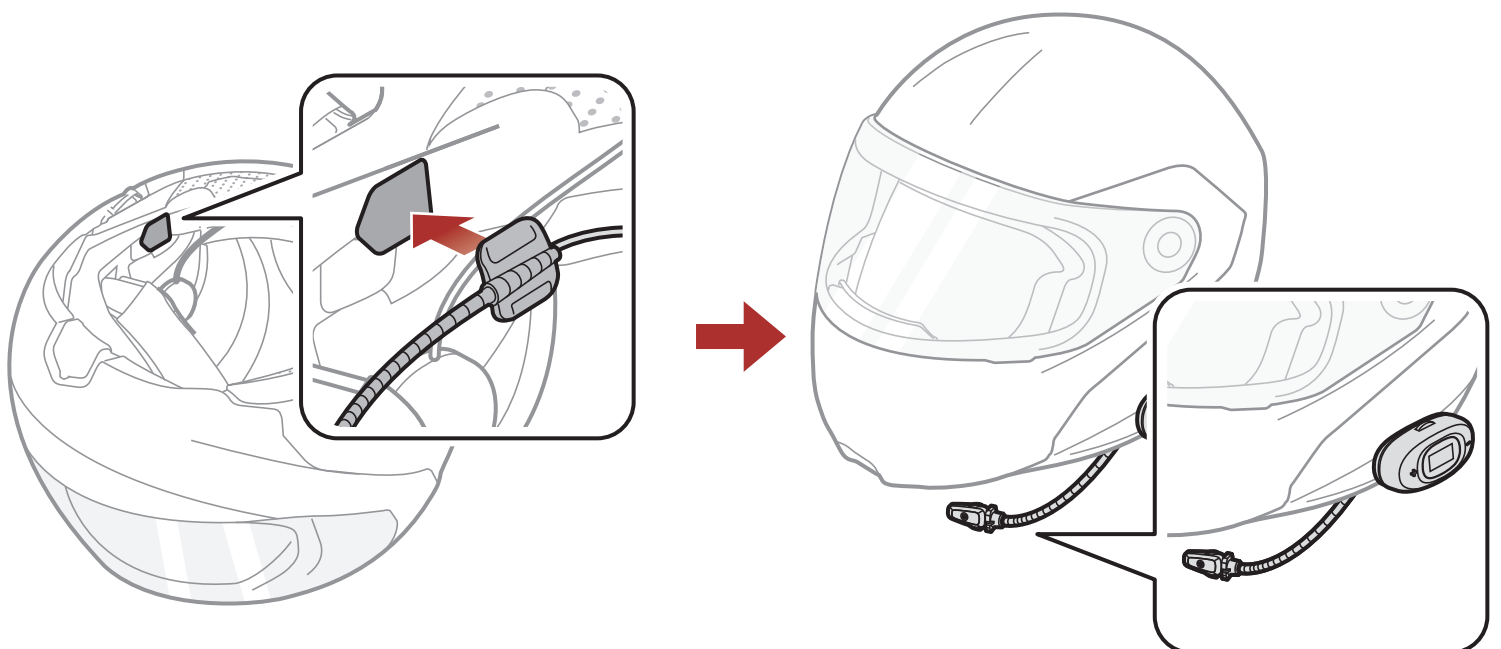

Note: You can use the wired boom microphone holder after attaching the hook and loop fastener for wired boom microphone holder on it to ensure secure installation.

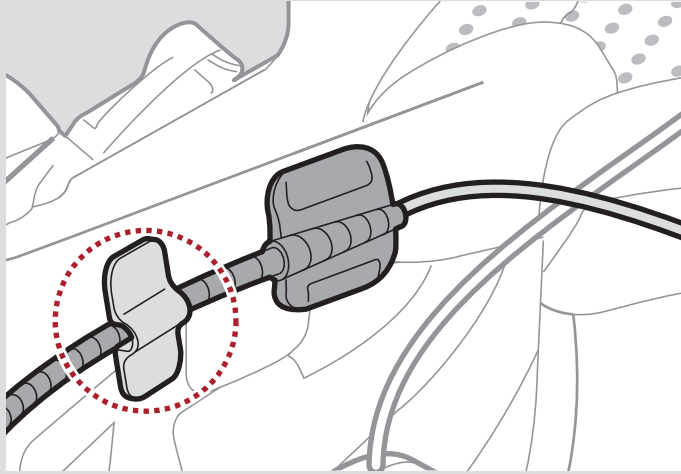

3. Align the arrows on the speakers and microphone cable's connector and wired boom microphone cable, and insert the wired boom microphone cable into the connector.

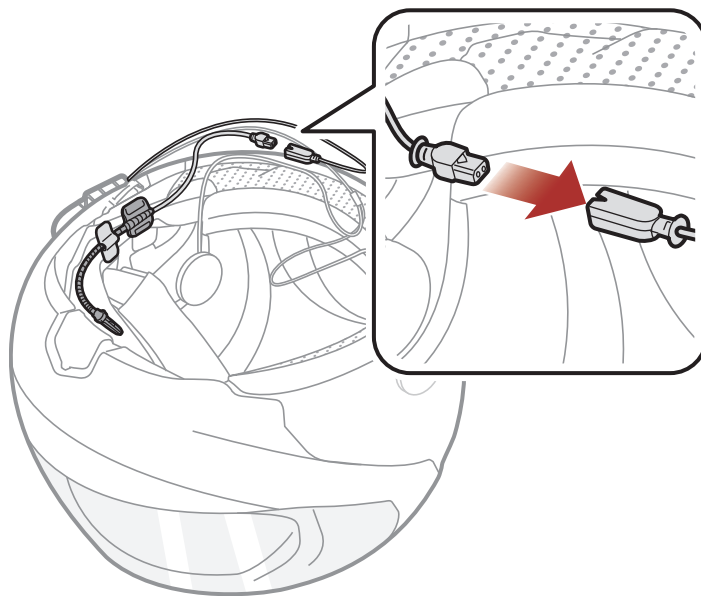

2.5.2 Installing the Wired Microphone

If you have a full face helmet, you can use the wired microphone.

1. Peel off the cover of the hook and loop fastener for wired microphone to expose the adhesive tape. Then, attach the hook and loop fastener on the inside of the helmet's chin guard.

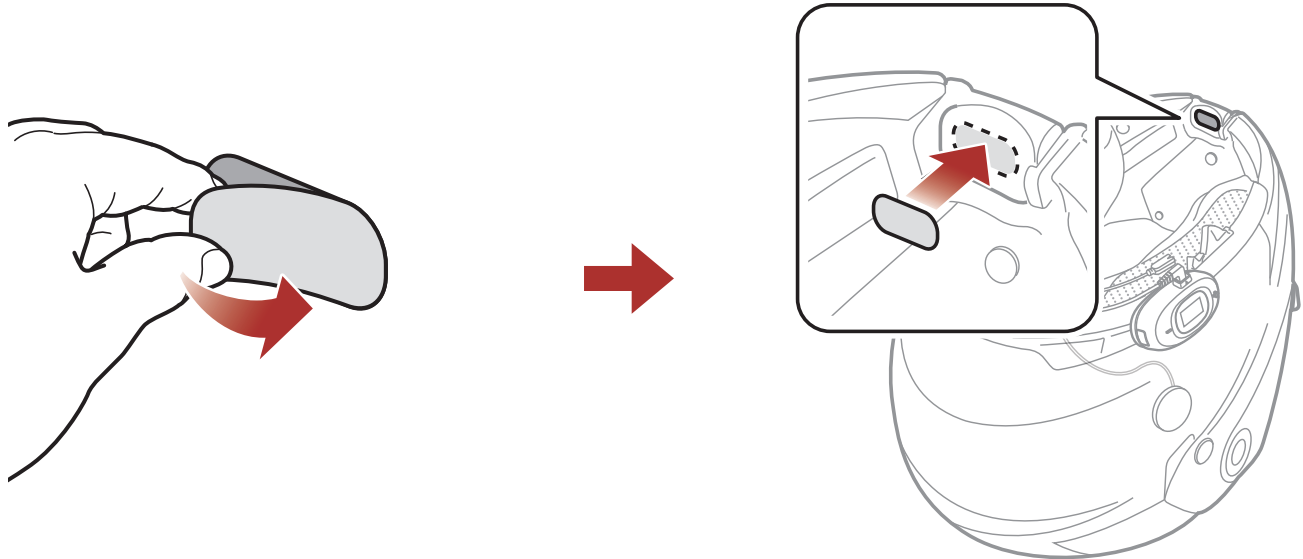

2. Attach the wired microphone to the hook and loop fastener for wired microphone.

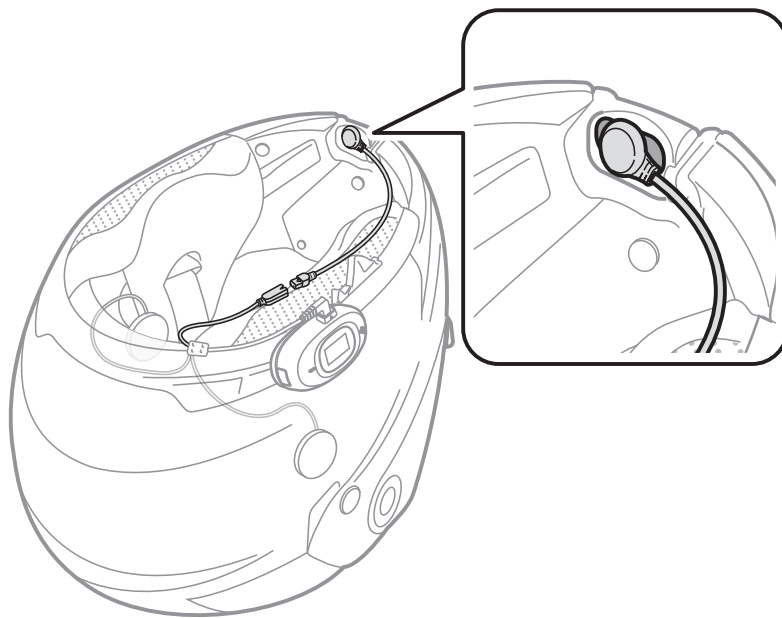

3. Align the arrows on the speakers and microphone cable's connector and wired microphone cable, and insert the wired microphone cable into the connector.

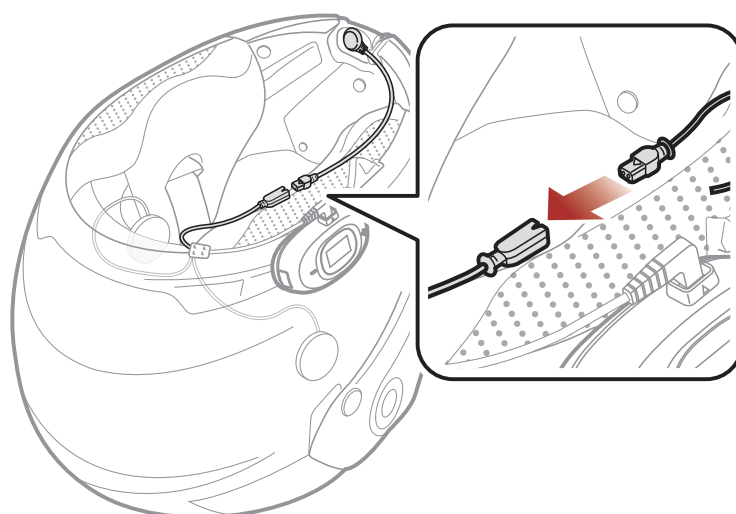

2.6 Cables Organization

After aligning the cables inside the helmet, reinstall the pads to the helmet.

2.7 Adjusting the Wired Boom Microphone Position

Make sure that the microphone is located properly close to your mouth when you wear the helmet.

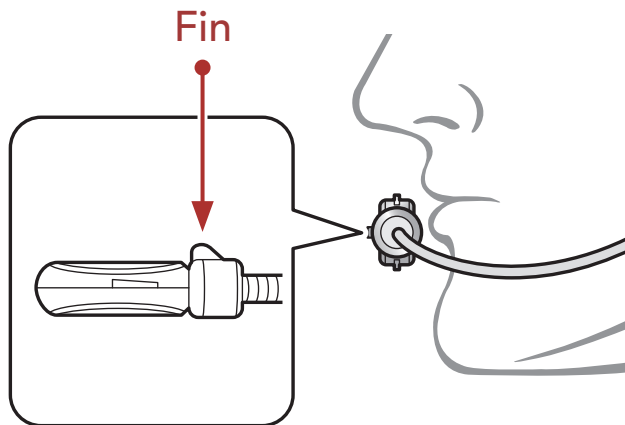

Adjust the direction of the microphone so that the fin side of the microphone is facing outward, away from your lips.

3. GETTING STARTED

3.1 Downloadable Sena Software

3.1.1 Sena Motorcycles App

By simply pairing your phone with your headset, you can use the **Sena Motorcycles App** for quicker, easier set up and management.



- Download the **Sena Motorcycles App** on **Google Play Store** or **App Store**.

3.1.2 Sena Device Manager

The **Sena Device Manager** allows you to upgrade firmware and configure settings directly from your PC.



- Download the **Sena Device Manager** at sena.com.

3.2 Charging

Charging the headset

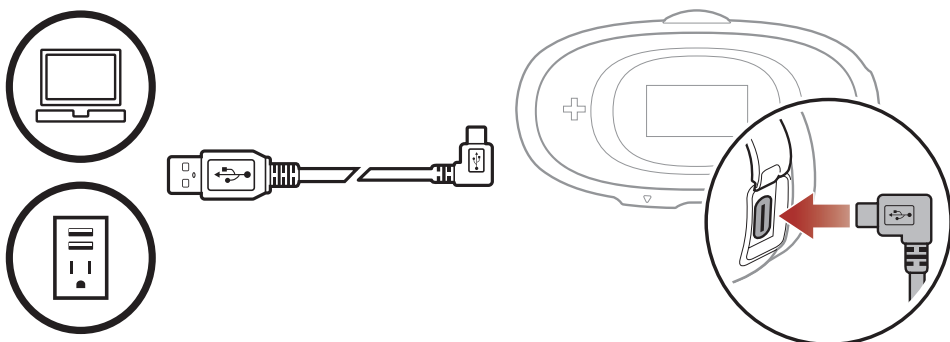

Depending upon the charging method, the headset will be fully charged in about 2.5 hours.

Note:

- Any 3rd party USB charger can be used with Sena products if the charger is approved by either the FCC, CE, IC, or other locally approved agencies.
- Use of a non-approved charger may cause fire, explosion, leakage, and other hazards which may also reduce the life time or performance of the battery.
- The **headset** is compatible with 5 V input USB-charged devices only.

3.3 Legend

 **Tap** button the specified number of times

 **Press and Hold** button for the specified amount of time



"Hello"

Audible prompt

3.4 Powering On and Off

Powering On



Powering Off







3.5 Checking the Battery Level

LCD Display



Battery Indicator

-  = High
-  = Medium
-  = Low
-  = Extremely Low
-  = Charging

3.6 Volume Adjustment

You can raise or lower the volume by tapping the **(+) Button** or the **(-) Button**. Volume is set and maintained independently at different levels for each audio source (i.e., phone, intercom), even when the headset is rebooted.

Volume Up & Down



 =  
 or
 =  

4. PAIRING THE HEADSET WITH OTHER BLUETOOTH DEVICES

When using the headset with other Bluetooth devices for the first time, they will need to be “paired.” This enables them to recognize and communicate with one another whenever they are within range.

The headset can pair with multiple Bluetooth devices such as a mobile phone, GPS, MP3 player or Sena SR10 Two-Way Radio Adapter via **Mobile Phone Pairing and Second Mobile Phone Pairing**.

4.1 Phone Pairing

There are three ways to pair the phone.

4.1.1 Initially Pairing the 5R

The headset will automatically enter the phone pairing mode when you initially turn on the headset or in the following situation:

- Rebooting after executing **Factory Reset**; or
- Rebooting after executing **Delete All Pairings**.

1. Press and hold the **(+) Button** and the **(-) Button** for **1 second**.

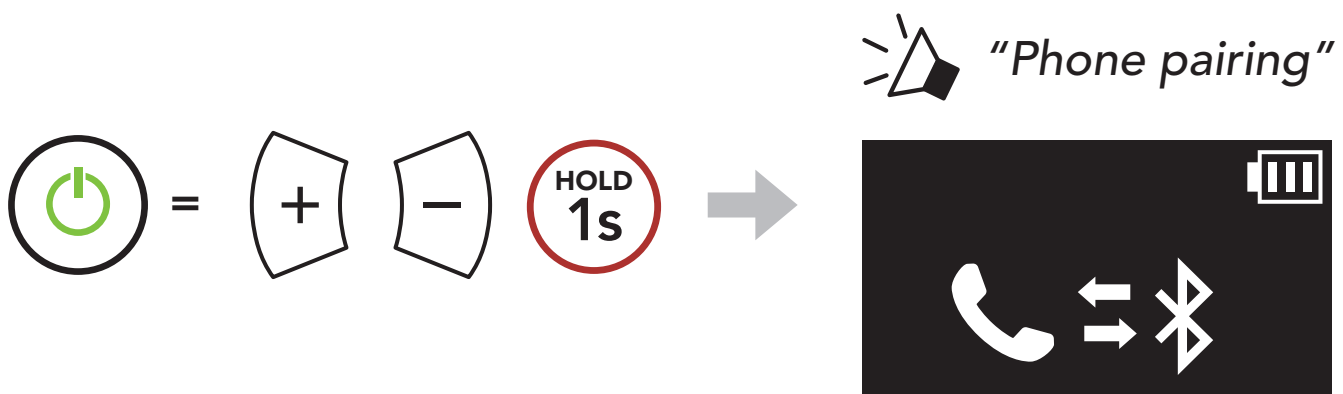

2. Select **5R** in the list of Bluetooth devices detected. If your mobile phone asks for a PIN, enter 0000.

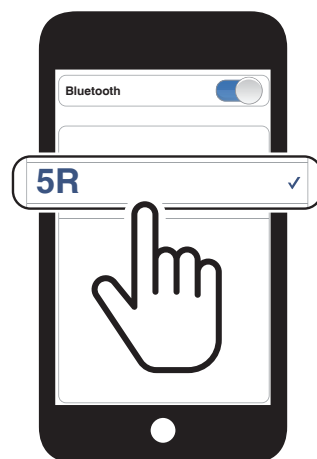

Note:

- The phone pairing mode lasts for **3 minutes**.
- To cancel phone pairing, tap the **Multi-function Button**.

4.1.2 Pairing When the 5R is Turned Off

1. While the headset is off, press and hold the **(+) Button** and the **(-) Button** until the LCD display screen changes to the phone pairing screen and you hear a voice prompt, **"Phone pairing."**

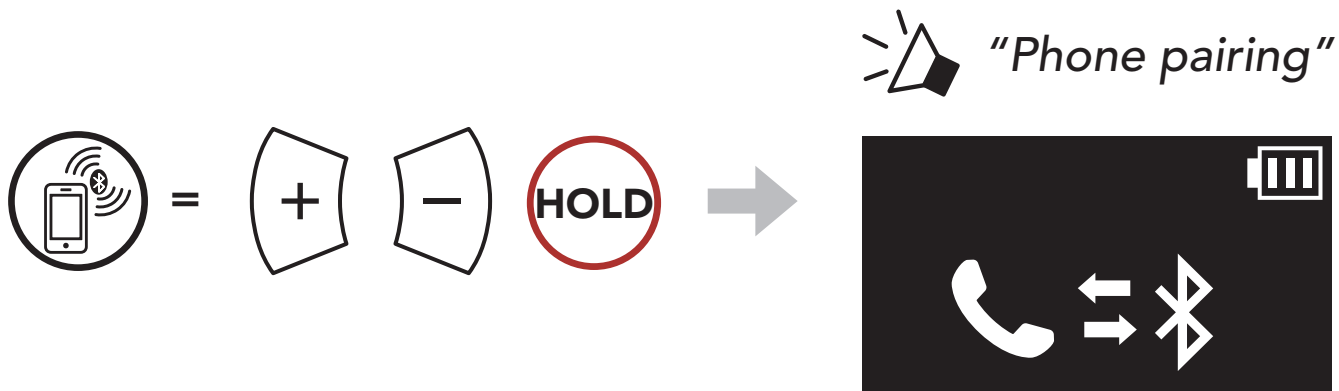

2. Select **5R** in the list of Bluetooth devices detected. If your mobile phone asks for a PIN, enter 0000.

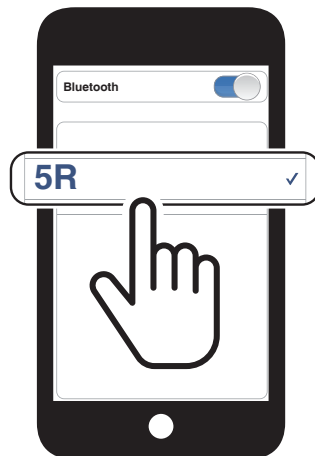

4.1.3 Pairing When the 5R is Turned On

1. While the headset is on, press and hold the **Multi-function Button** for **10 seconds**.

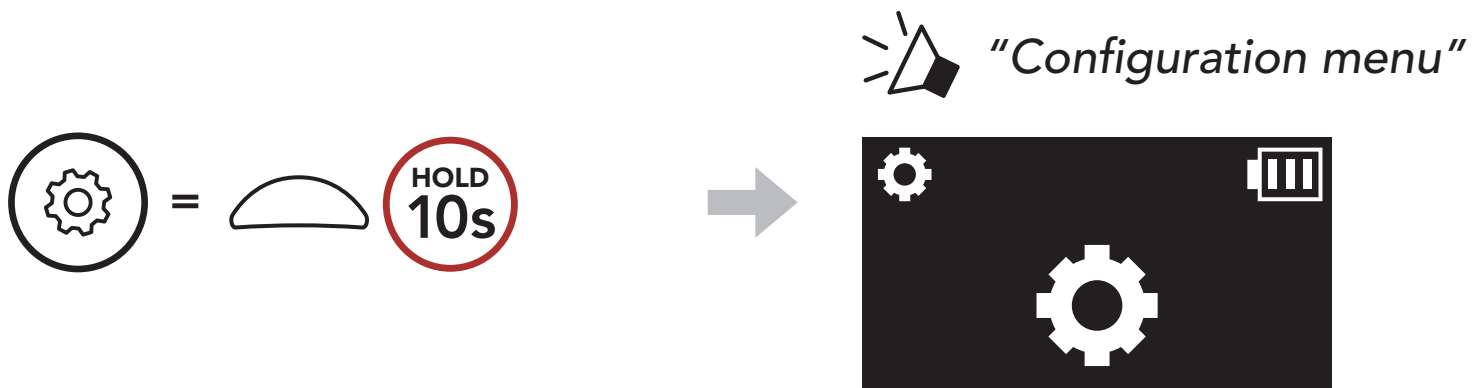

2. Tap the **(+) Button**.

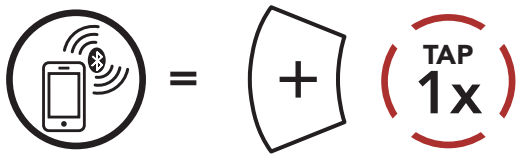

 "Phone pairing"

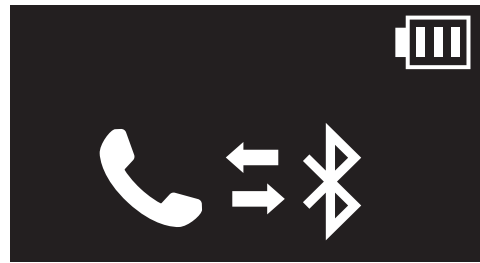

3. Select **5R** in the list of Bluetooth devices detected. If your mobile phone asks for a PIN, enter 0000.

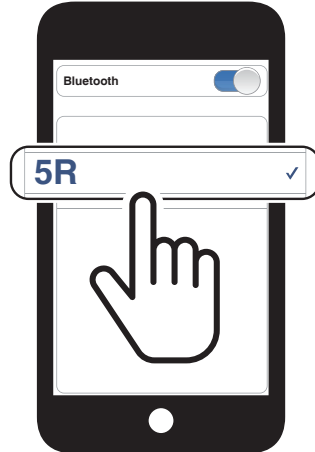

4.2 Second Mobile Phone Pairing - Second Mobile Phone, GPS, and SR10

1. Press and hold the **Multi-function Button** for **10 seconds**.

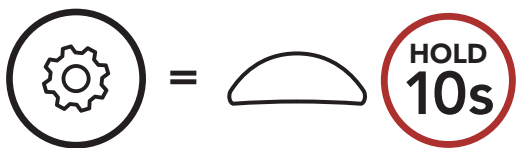

 "Configuration menu"



2. Double tap the **(+) Button**.

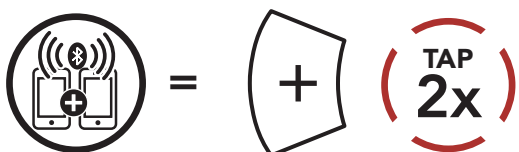

 "Second mobile phone pairing"

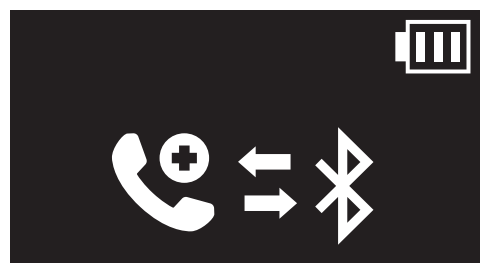

3. Select **5R** in the list of Bluetooth devices detected. If your Bluetooth device asks for a PIN, enter 0000.

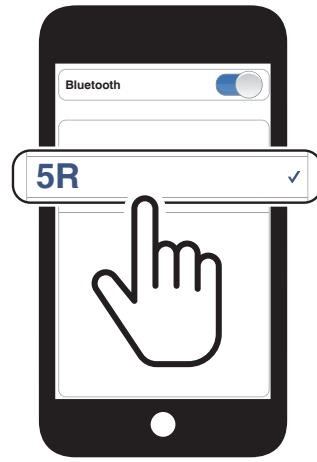

4.3 GPS Pairing

1. Press and hold the **Multi-function Button** for **10 seconds**.

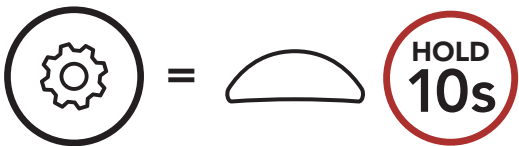

 "Configuration menu"



2. Tap the **(+) Button** **3 times**.

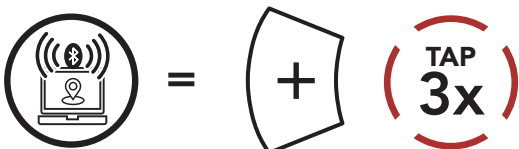

 "GPS pairing"

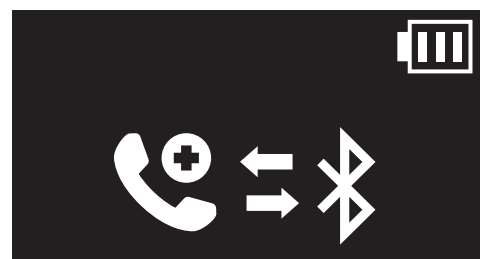

3. Select **5R** in the list of devices detected. If your Bluetooth device asks for a PIN, enter 0000.



4.4 Advanced Selective Pairing: Hands-Free or A2DP Stereo

Phone Pairing allows the headset to establish two Bluetooth profiles: **Hands-Free** or **A2DP Stereo**. **Advanced Selective Pairing** allows the headset to separate the profiles to enable connection with two devices.

4.4.1 Phone Selective Pairing - Hands-Free Profile

1. Press and hold the **Multi-function Button** for **10 seconds**.

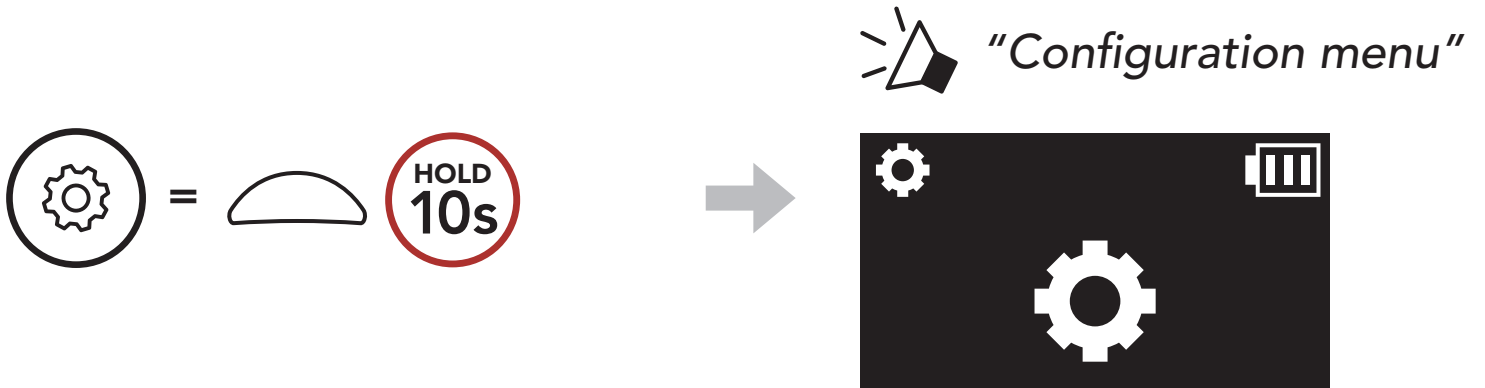

2. Tap the **(+) Button** **4 times**.

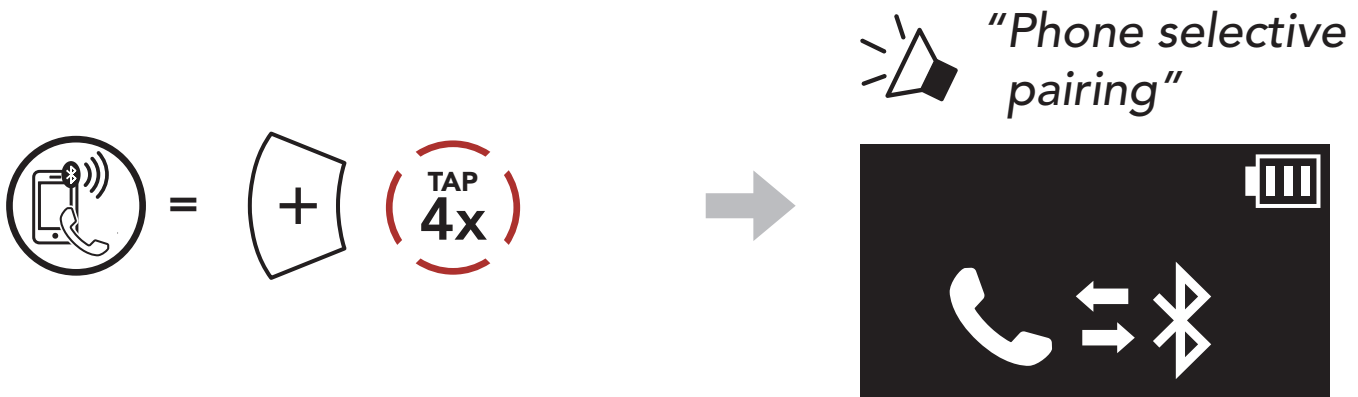

3. Select **5R** in the list of Bluetooth devices detected. If your mobile phone asks for a PIN, enter 0000.

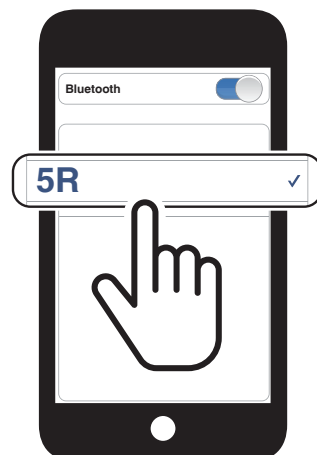

4.4.2 Media Selective Pairing - A2DP Profile

1. Press and hold the **Multi-function Button** for **10 seconds**.

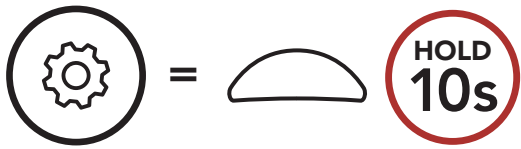

 "Configuration menu"



2. Tap the **(+) Button** 5 times.



 "Media selective pairing"



3. Select **5R** in the list of Bluetooth devices detected. If your mobile phone asks for a PIN, enter 0000.

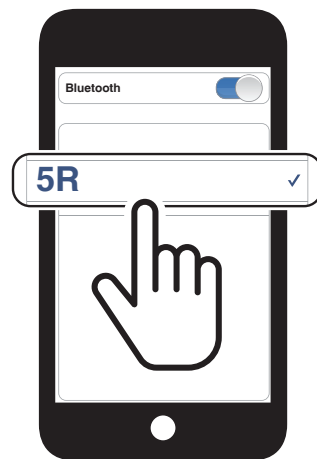





5. MOBILE PHONE USAGE

5.1 Making and Answering Calls

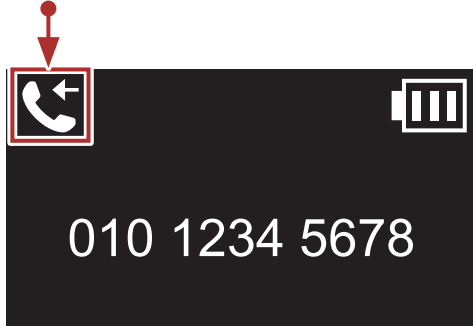
LCD Display

Call Status



-  = Incoming Call
-  = Outgoing call
-  = On the Phone Call
-  = Reject a call

Answer a Call

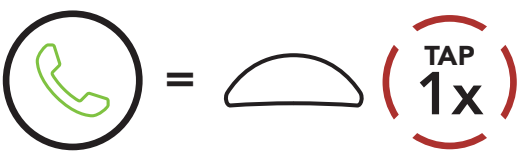

End a Call

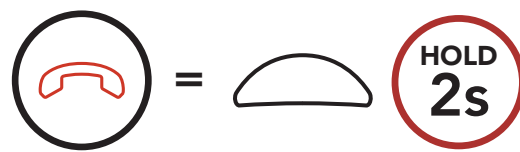

Reject a Call

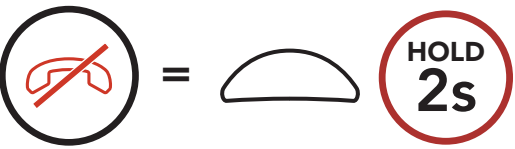

Make a Call with Voice Dialer

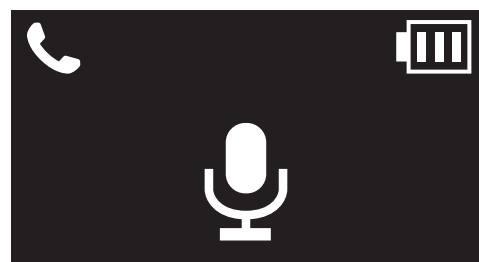

5.2 Speed Dialing

5.2.1 Assigning Speed Dial Presets

Speed Dial Presets could be assigned through the **Sena Motorcycles App**.

5.2.2 Using Speed Dial Presets

1. Enter into the **Speed Dial** menu.

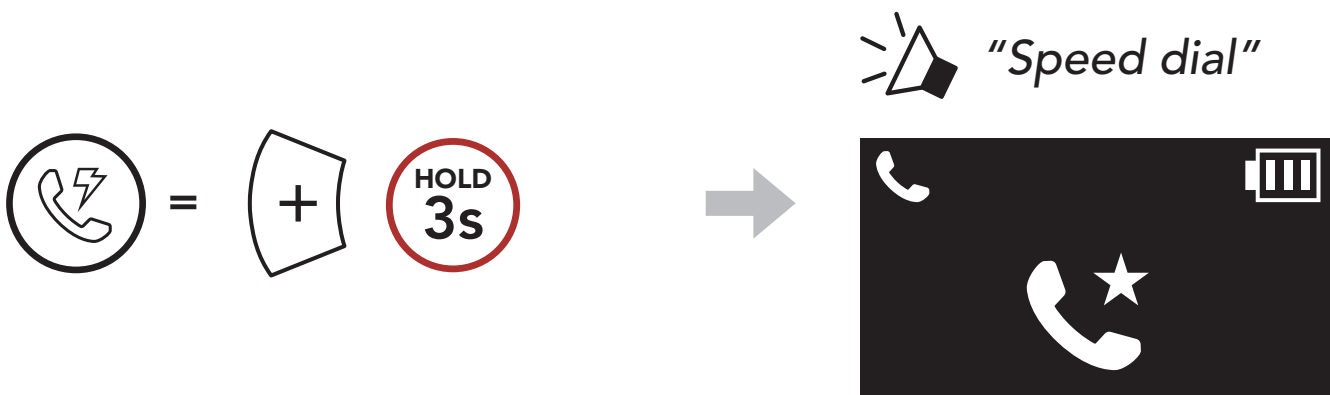

2. Navigate forward or backward through **Speed Dial Preset** numbers.

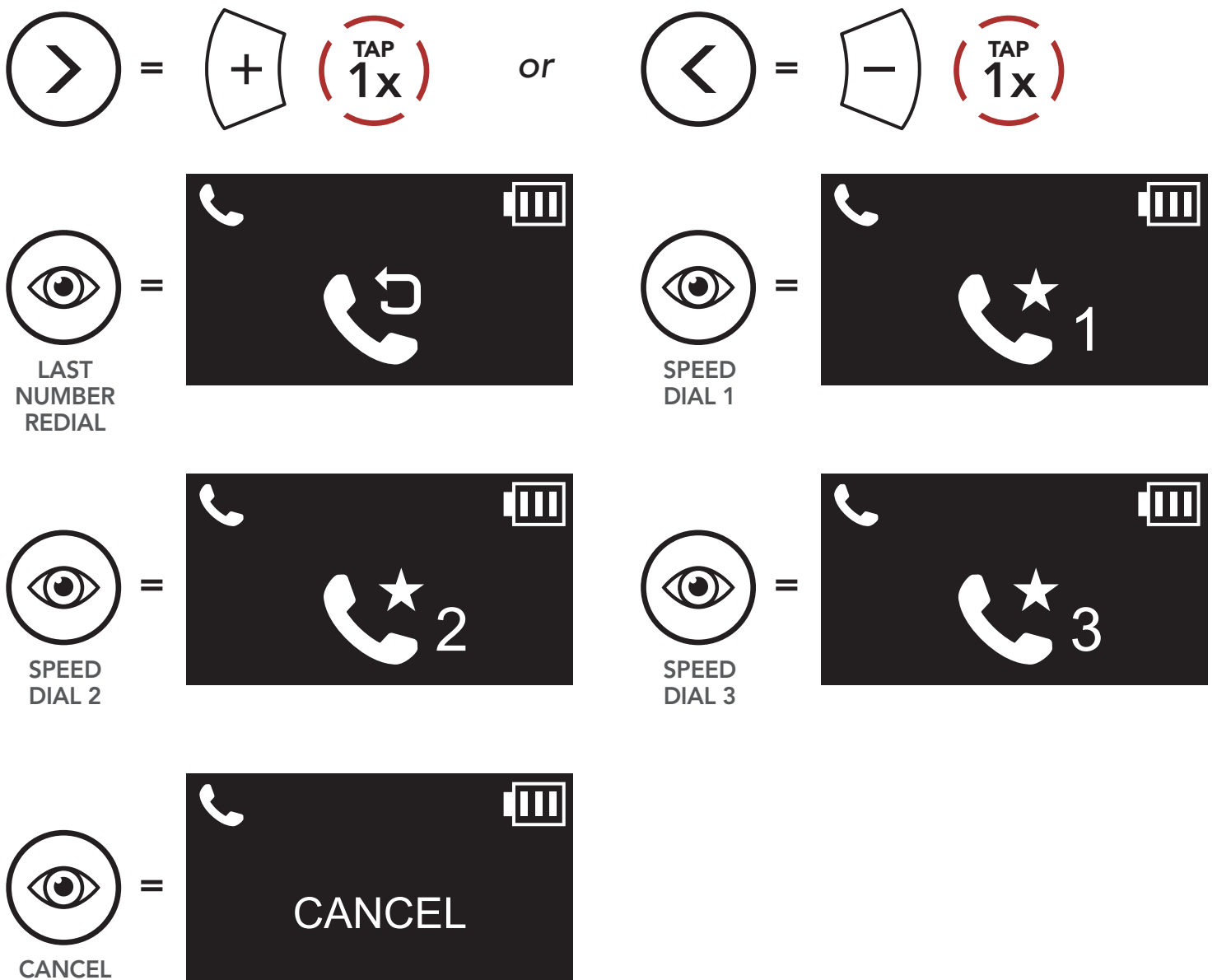

3. Call one of your **Speed Dial Presets** numbers.



4. Redial the last number called.

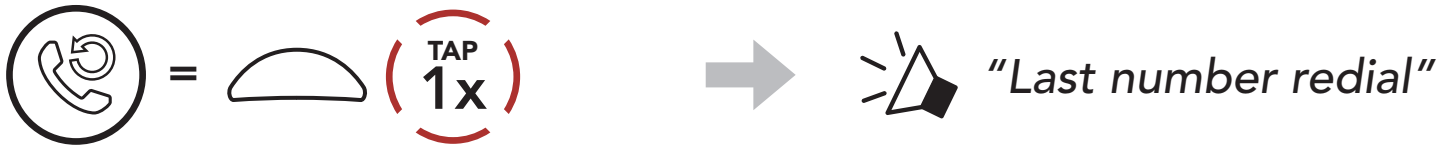

6. STEREO MUSIC

6.1 Bluetooth Stereo Music

Play/Pause Music

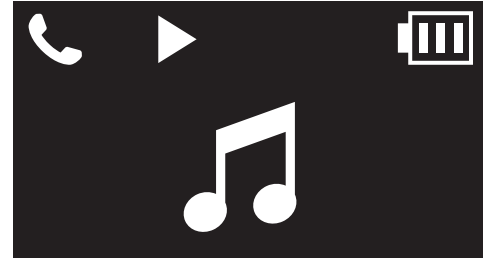
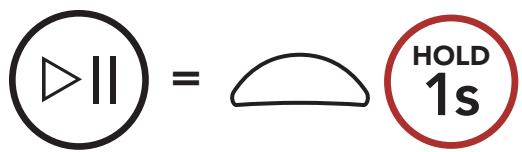

or

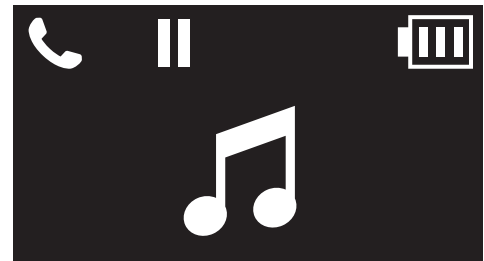

Next Track

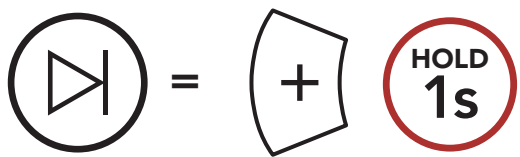

Previous Track

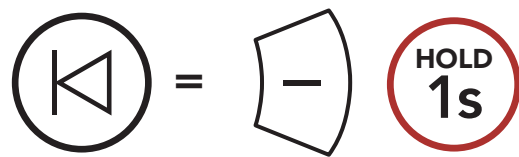

6.2 Music Sharing

You can start sharing music with one intercom friend using Bluetooth stereo music during a **Two-way intercom conversation**. When you terminate music sharing, you can go back to the intercom conversation.

Note:

- Both you and your intercom friend can remotely control music playback such as track forward and track back.
- **Music sharing** will be paused when you are using your mobile phone or listening to GPS instructions.
- When Audio Multitasking is enabled, if an intercom call is made when you are listening to music, music sharing will not work.

Start/Terminate Sharing Music

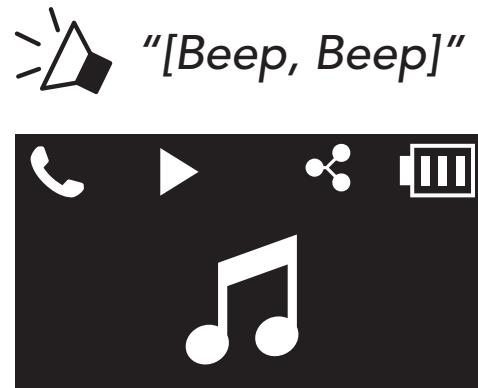
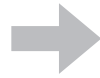
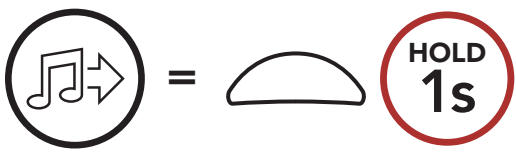

7. BLUETOOTH INTERCOM

Up to three other people can be paired with the headset for Bluetooth intercom conversations.

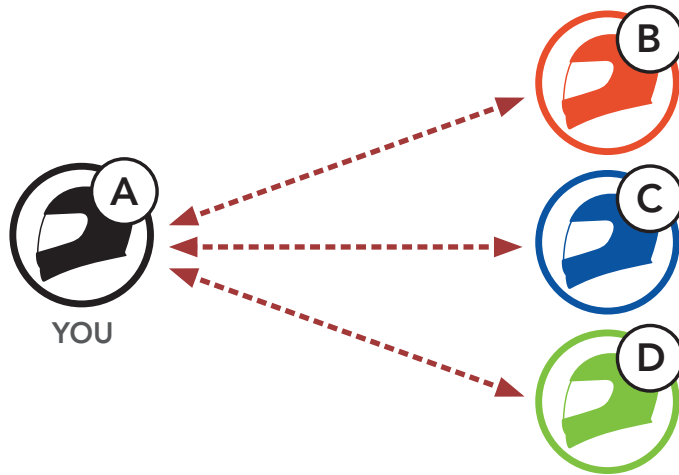



7.1 Intercom Pairing

There are two ways to pair the headset.

7.1.1 Using the Smart Intercom Pairing (SIP)

SIP allows you to quickly pair with your friends for intercom communication by scanning the QR code on the **Sena Motorcycles App** without remembering the button operation.

1. Pair the mobile phone with the headset.
2. Open the **Sena Motorcycles App** and tap  (**Smart Intercom Pairing Menu**).
3. Scan the **QR code** displayed on your friend (**B**)'s mobile phone.
 - Your friend (**B**) can display the QR code on the mobile phone by tapping  > **QR code** () on the **Sena Motorcycles App**.

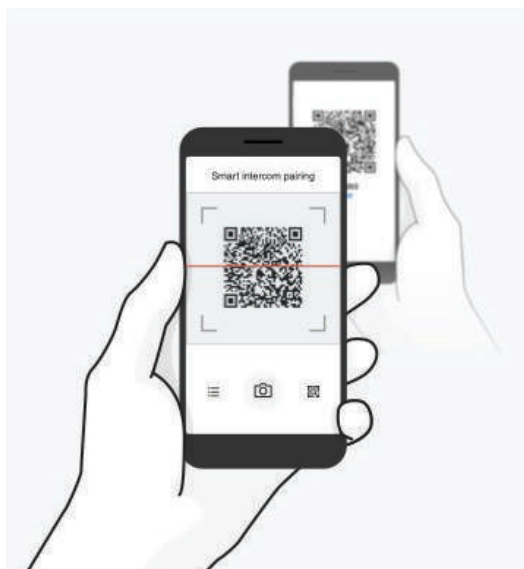

4. Tap **Save** and check that your friend **(B)** is paired with **you (A)** correctly.
5. Tap **Scan** (📷) and repeat steps 3-4 to pair with **Intercom Friends (C)** and **(D)**.

Note: The **Smart Intercom Pairing (SIP)** is not compatible with Sena products that use **Bluetooth 3.0** or **below**.

7.1.2 Using the Button



1. **Users (You, B)** enter into **Intercom Pairing**.

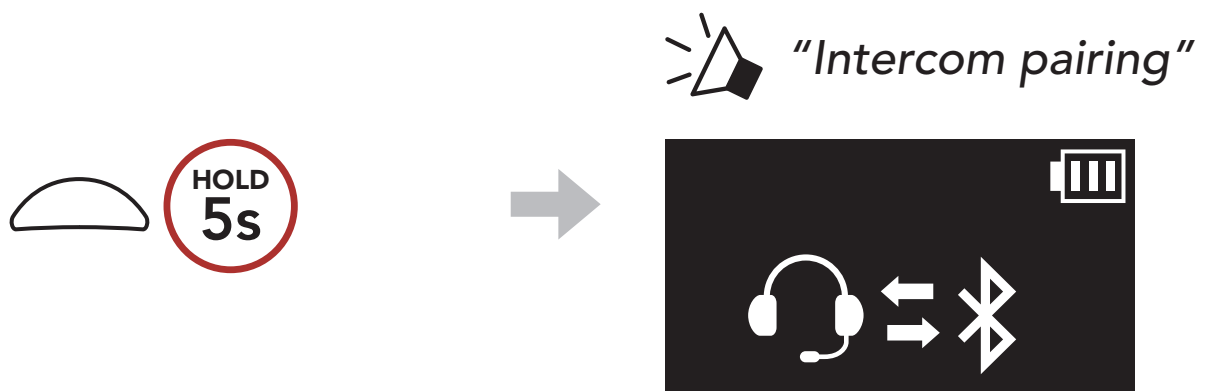

2. Tap the **Multi-function Button** on either headset.

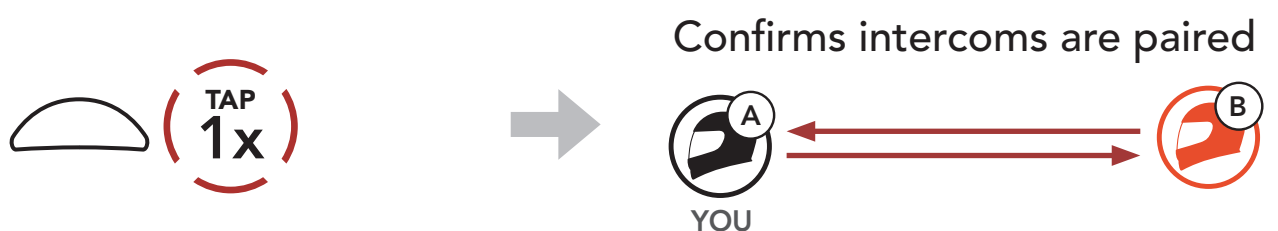

3. Repeat the steps above to pair with **other headsets (C and D)**.

7.2 Last-Come, First-Served

The intercom pairing queue is **Last-Come, First-Served**. If the headset has multiple paired headsets for intercom conversations, the last paired headset is set as the **First Intercom Friend**. For example, after the pairing procedures listed above, **headset (D)** is the **First Intercom Friend** of headset (A). **headset (C)** is the **Second Intercom Friend** of headset (A), and **headset (B)** is the **Third Intercom Friend** of headset (A).

Intercom Pairing Order

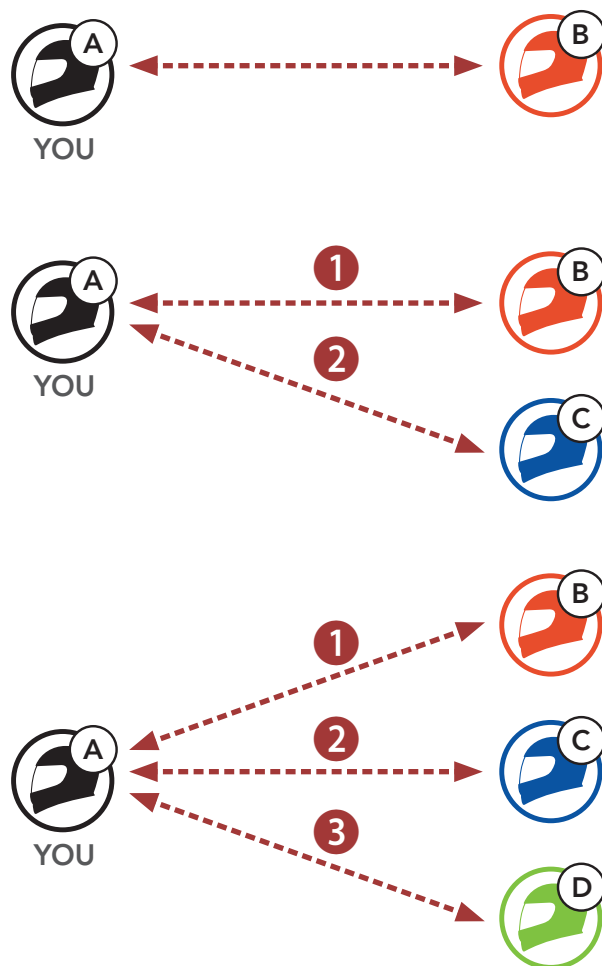

Last-Come, First-Served

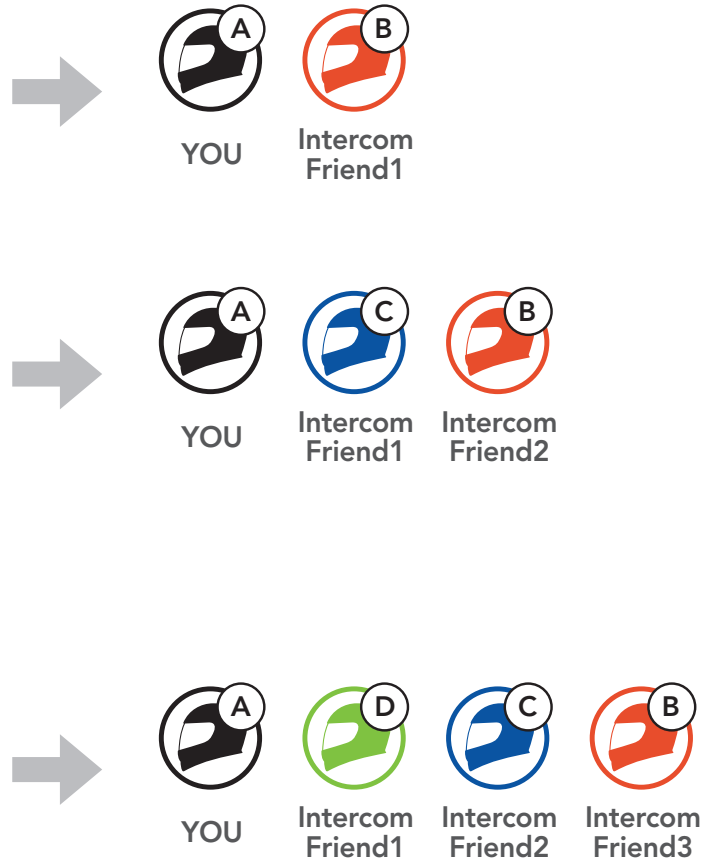

7.3 Two-Way Intercom

You can start or end an intercom conversation with an **Intercom Friend**.



Start/End Conversation with the First Intercom Friend D

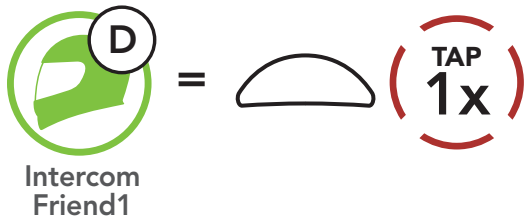

Start/End Conversation with the Second Intercom Friend C

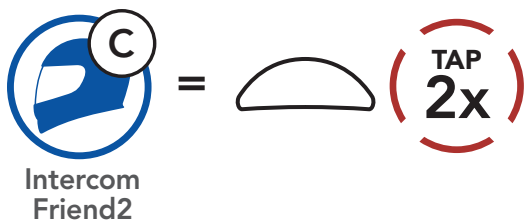

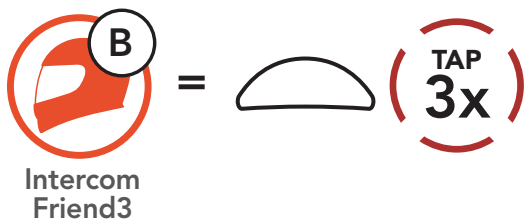

Start/End Conversation with the Third Intercom Friend B



8. UNIVERSAL INTERCOM

Universal Intercom allows you to have intercom conversations with users of non-Sena Bluetooth headsets. Non-Sena Bluetooth headset can be connected to the Sena headset if they support the **Bluetooth Hands-Free Profile (HFP)**. You can pair the headset with only one non-Sena headset at a time. The intercom distance depends on the performance of the headset to which it's connected. When a non-Sena headset is paired with the headset while another Bluetooth device is paired via **Second Mobile Phone Pairing**, it will be disconnected.

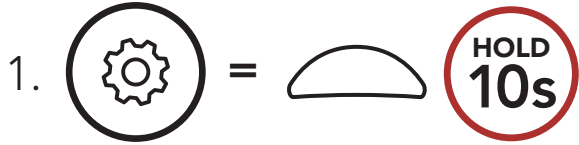
8.1 Universal Intercom Pairing

-  → 

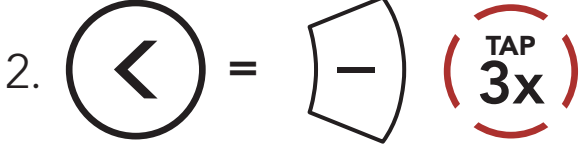
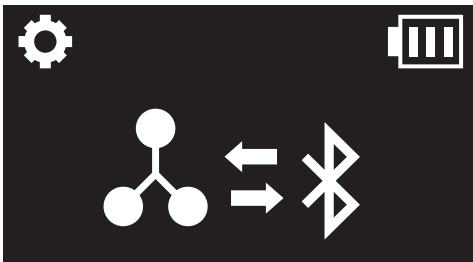
"Configuration menu"
-  → 

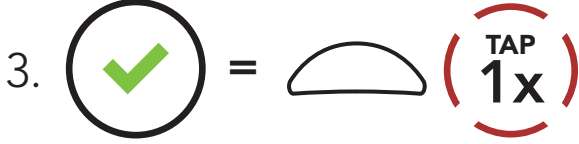
"Universal intercom pairing"
-  → Enter into **Universal Intercom Pairing** mode.
- Put the non-Sena headset in Hands-free Pairing Mode. The headset will automatically pair with a non-Sena Bluetooth headset.

8.2 Two-Way Universal Intercom

You can initiate the **Universal Intercom** connection with non-Sena Bluetooth headsets using the same intercom connection method as you would between other Sena headsets.

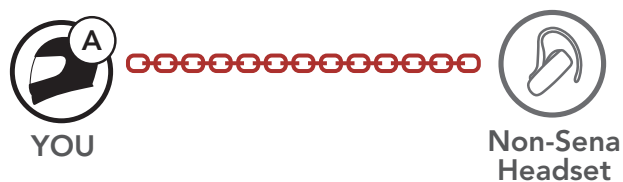

You may start/end a **Two-Way Universal Intercom** using the same way as you do in a normal **Two-Way Intercom**. Please refer to **Section 7.3: "Two-Way Intercom"**.

9. FUNCTION PRIORITY AND FIRMWARE UPGRADES

9.1 Function Priority

The **headset** operates in the following order of priority:

- (highest)** Mobile phone
- Intercom
- Music sharing via Bluetooth stereo music
- (lowest)** Bluetooth stereo music

A lower priority function is always interrupted by a higher priority function.

Note: If you select music as the audio source priority, the order of priority will change as below:

- (highest)** Mobile phone
- Bluetooth stereo music
- Intercom
- (lowest)** Music sharing via Bluetooth stereo music

9.2 Firmware Upgrades

You can upgrade firmware using the **Sena Device Manager**.

The **USB Power & Data Cable (USB-C)** must be connected to your **PC** to upgrade firmware using the **Sena Device Manager**.

Please visit [sena.com](https://www.sena.com) to check for the latest software downloads.

[Click Here to Visit sena.com](https://www.sena.com)

10. CONFIGURATION SETTING

10.1 Headset Configuration Menu

Accessing the Configuration Menu

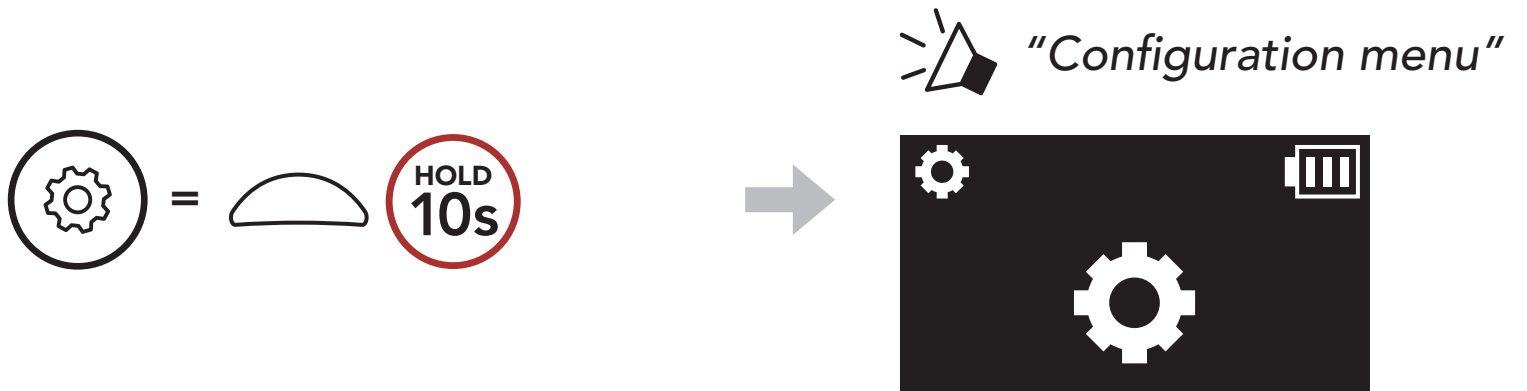

Navigating Between Menu Options

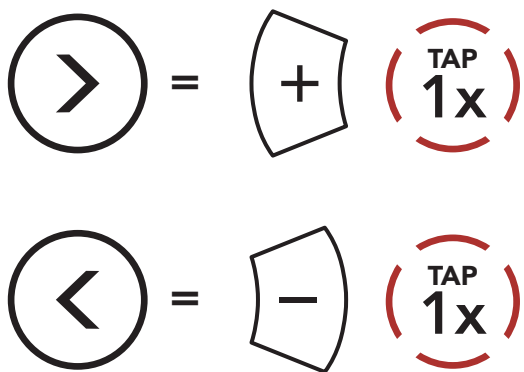

Execute Menu Options

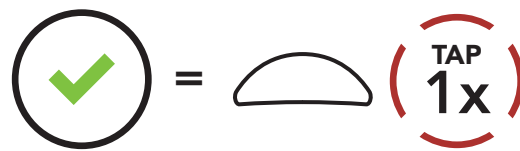

Headset Configuration Menu

Voice Configuration Menu	Tap the Multi-function Button
Phone Pairing	None
Second Mobile Phone Pairing	None
GPS Pairing	None
Phone Selective Pairing	None
Media Selective Pairing	None
Delete All Pairings	Execute
Remote Control Pairing	Execute
Universal Intercom Pairing	Execute
Factory Reset	Execute
Exit	Execute

10.1.1 Delete All Pairings

Delete All Bluetooth Pairing Information stored in the headset.

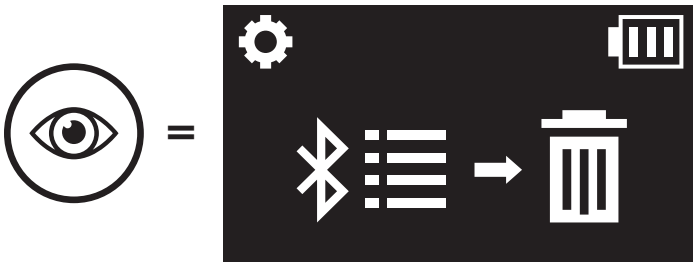

10.1.2 Remote Control Pairing

You can remotely control the headset using **Sena Remote Control devices** (sold separately).

1. Turn on the headset and the Remote Control device.
2. Execute **Remote Control Pairing**.

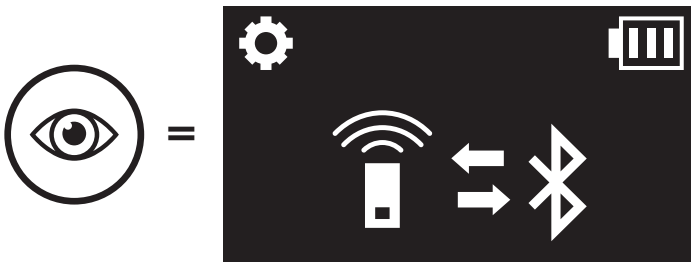

3. Enter pairing mode in the Remote Control device. The headset will automatically connect with the Remote Control device in pairing mode.

10.2 Software Configuration Setting

You can change the settings of the headset through the **Sena Motorcycles App** or the **Sena Device Manager**.



10.2.1 Headset Language

You can select the device language. The selected language is maintained even when the headset is rebooted.

10.2.2 Audio Source Priority (Default: Intercom)

Audio Source Priority allows you to select the priority between the intercom and music (which includes GPS app instructions and message notifications) from a smartphone. If the intercom is selected as the audio source priority, your music will be interrupted during an intercom conversation. If music is selected as the audio source priority, intercom conversations will be interrupted while your music is heard.

Note: Audio Source Priority is active only when **Audio Multitasking** is disabled.

10.2.3 VOX Phone (Default: Enable)

If this feature is enabled, you can answer incoming calls by voice. When you hear a ringtone for an incoming call, you can answer the phone by saying a word such as **"Hello"** loudly or by blowing air into the microphone. **VOX Phone** is temporarily disabled if you are connected to intercom. If this feature is disabled, you have to tap the **Multi-function Button** to answer an incoming call.

10.2.4 VOX Intercom (Default: Disable)

If **VOX Intercom** is enabled, you can initiate an intercom conversation with the last connected intercom friend by voice. When you want to start intercom, say a word such as **"Hello"** loudly or blow air into the microphone. If you start an intercom conversation by voice, the intercom terminates automatically when you and your intercom friend remain silent for 20 seconds. However, if you manually start an intercom conversation by tapping the **Multi-function Button**, you have to terminate the intercom conversation manually. However, if you start the intercom by voice and end it manually by tapping the **Multi-function Button**, you will not be able to start intercom by voice temporarily. In this case, you have to tap the **Multi-function Button** to restart the intercom. This is to prevent repeated unintentional intercom connections by strong wind noise. After rebooting the headset, you can start the intercom by voice again.

10.2.5 Audio Multitasking™ (Default: Disable)

Audio Multitasking allows you to hear the audio from two features simultaneously. When **Audio Multitasking** is enabled, phone calls, GPS instructions, and intercom conversations can be overlaid with audio from the music or GPS app instructions from a smartphone in the background with reduced volume. Increasing or decreasing the volume of the audio in the foreground will also increase or decrease the volume of the overlaid audio in the background. The volume of the foreground audio can be adjusted using the headset. How much background audio that is heard can be adjusted using the **Sena Device Manager** or the **Sena Motorcycles App**. **HD Intercom**, **HD Voice**, and **Audio Source Priority** become disabled temporarily when **Audio Multitasking** is enabled.

Foreground and Background Combination Table

Model	Foreground*			Background**
	Phone	GPS	Intercom	Music or Smart Navi
5R	<input type="radio"/> ^A	<input type="radio"/> ^A		
		<input type="radio"/>	<input type="radio"/>	
			<input type="radio"/> ^B	<input type="radio"/> ^B
		<input type="radio"/>		<input type="radio"/>

* Two audio sources in the foreground can be heard simultaneously with the same volume level.

** Only one background source can be heard at a time while listening to an audio source in the foreground.

A. GPS instructions can be heard during phone calls and the volume level of both audio sources can be adjusted using the headset.

B. GPS app directions will be heard in the background during intercom conversations.

Note:

- **Audio Multitasking** will be activated during two-way intercom conversations with a headset that also supports this feature.
- When **Audio Multitasking** is disabled, the background audio source will return to its independent volume level.
- For **Audio Multitasking** to work properly, you need to power the headset off and on. Please restart the headset.
- Some GPS devices may not support this feature.

10.2.6 Background Volume (Default: Level 5)

The **Background Volume** can be adjustable only when the **Audio Multitasking** turns on. Level 9 is the highest volume and 0 is the lowest.

10.2.7 HD Intercom (Default: Enable)

HD Intercom enhances the two-way intercom audio from normal quality to HD quality. If this feature is disabled, the two-way intercom audio will change to normal quality.

Note:

- The intercom distance of **HD Intercom** is relatively shorter than that of normal intercom.
- **HD Intercom** will become disabled temporarily when **Audio Multitasking** is enabled.

10.2.8 HD Voice (Default: Enable)

HD Voice allows you to communicate in high-definition during phone calls. This feature increases the quality so that the audio will be crisp and clear during phone call conversations.

If this feature is enabled, incoming phone calls will interrupt intercom conversations and audio from the SR10 will not be heard during intercom conversations.

Note:

- Refer to the manufacturer of your Bluetooth device that will be connected to the headset to see if it supports **HD Voice**.
- **HD Voice** is active only when **Audio Multitasking** is disabled.

10.2.9 Voice Prompt (Default: Enable)

You can disable **Voice Prompts** by software configuration settings, but the following voice prompts are always on.

- Headset configuration settings menu, battery level indicator, speed dial

10.2.10 Advanced Noise Control™ (Always On)

The background noise is reduced during an intercom conversation.

11. TROUBLESHOOTING

Please visit [sena.com](https://www.sena.com) for more troubleshooting information.

- Customer Support: [sena.com](https://www.sena.com)

11.1 Fault Reset

When the headset is not working properly, you can easily reset the unit:

1. Locate the **Pinhole Fault Reset Button** below on the back of the main unit.
2. Gently insert a paper clip into the hole and press the **Pinhole Fault Reset Button** with light pressure.

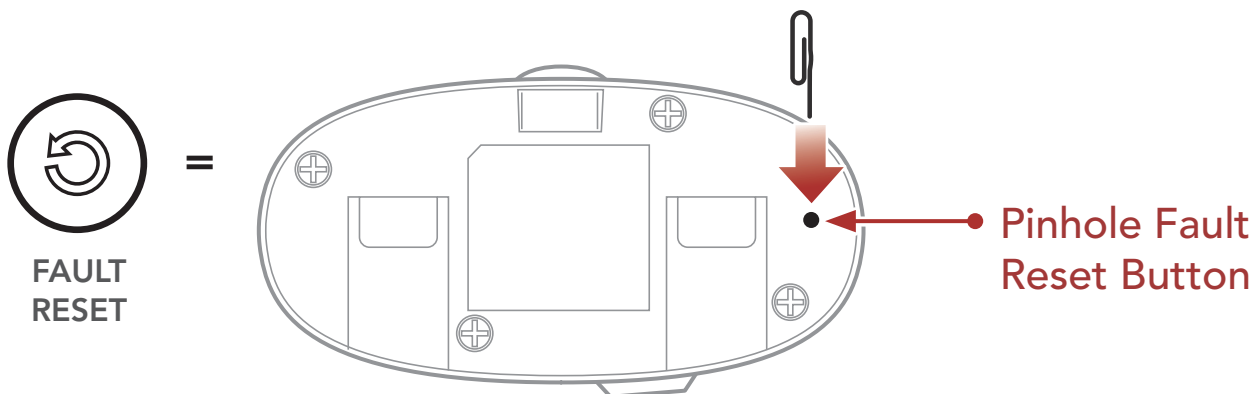















3. The headset will shut down.

Note: Fault Reset will not restore the headset to factory default settings.

11.2 Factory Reset

To erase all of your settings and start fresh, the headset can be restored to factory default settings using the **Factory Reset** feature.

1.  =   →   "Configuration menu"
2.  =   →   "Factory reset"
3.  =   →   "Headset reset, good-bye"



Copyright © 2023 Sena Technologies, Inc.
All rights reserved.

© 1998–2023 Sena Technologies, Inc. All rights reserved.

Sena Technologies, Inc. reserves the right to make any changes and improvements to its product without providing prior notice.

Sena™ is a trademark of Sena Technologies, Inc. or its subsidiaries in the USA and other countries. SF1™, SF2™, SF4™, SFR™, SRL™, SRL2™, SRL-EXT™, SRL-Mesh™, Momentum™, Momentum INC™, Momentum Lite™, Momentum Pro™, Momentum INC Pro™, Momentum EVO™, Cavalry™, Latitude SR™, Latitude SX™, Latitude S1™, 30K™, 33i™, 50S™, 50R™, 50C™, 5S™, 5R™, 5R LITE™, 20S EVO™, 20S™, 10S™, 10C™, 10C PRO™, ProRide EVO™, 10C EVO™, 10U™, 10Upad™, 10R™, ACS10™, ACS-RAM™, C1™, C10™, CAST™, 3S™, 3S PLUS™, SMH5™, SMH5-FM™, SMH5 MultiCom™, SMH10™, SMH10R™, SPH10™, SPH10H-FM™, Savage™, Prism Tube WiFi™, Prism™, Bluetooth Audio Pack for GoPro®, Impulse™, FURY™, R1™, R1 EVO™, R1 EVO CS™, R2™, R2 EVO™, R2X™, M1™, M1 EVO™, RUMBA™, RC1™, RC3™, RC4™, Stryker™, Handlebar Remote™, Wristband Remote™, PowerPro Mount™, Powerbank™, FreeWire™, WiFi Docking Station™, WiFi Sync Cable™, WiFi Adapter™, +mesh™, +Mesh Universal™, MeshPort Blue™, MeshPort Red™, MeshPort Black™, Econo™, OUTLANDER M™, OUTRUSH™, OUTRUSH R™, OUTSTAR™, OUTSTAR S™, OUTFORCE™, OUTRIDE™, OUTRUSH M™, SPLASH™, EcoCom™, Parani A10™, Parani A20™, Parani M10™, pi™, Snowtalk™, Snowtalk2™, SR10™, SR10i™, SM10™, SPIDER RT1™, SPIDER ST1™, X1™, X1 Pro™, X1S™, EXPAND™, EXPAND BOOM™, EXPAND MESH™, Bluetooth Mic & Intercom™, Tufftalk™, Tufftalk Lite™, Tufftalk M™ are trademarks of Sena Technologies, Inc. or its subsidiaries. These trademarks may not be used without the express permission of Sena.

GoPro® is a registered trademark of Woodman Labs of San Mateo, California. Sena Technologies, Inc. ("Sena") is not affiliated with Woodman Labs, Inc. The Sena Bluetooth Pack for GoPro® is an aftermarket accessory specially designed and manufactured by Sena Technologies, Inc. for the GoPro® Hero3 and Hero4 allowing for Bluetooth capabilities.

The Bluetooth® word mark and logos are owned by the Bluetooth SIG, Inc. and any use of such marks by Sena is under license. iPhone® and iPod® touch are registered trademarks of Apple Inc.

Address: 152 Technology Drive Irvine, CA 92618